

Resistor LED for 12 V Supply Voltage

Description

These devices are developed for the automotive industry with special requirements as for EMC (electro magnetic compatibility) in motor vehicles with 12 V supply voltage.

They are resistant against transient conduction (high voltage spikes) and interferences by conduction and coupling.

The TLR.442. series contains an integrated resistor for current limiting in series with the LED chip. This allows the lamp to be driven from a 12 V source without an external current limiter.

Available colors are red, soft orange, yellow and green. These tinted diffused lamps provide a wide off-axis viewing angle.

These LEDs are intended for space critical applications such as automobile instrument panels, switches and others which are driven from a 12 V source.

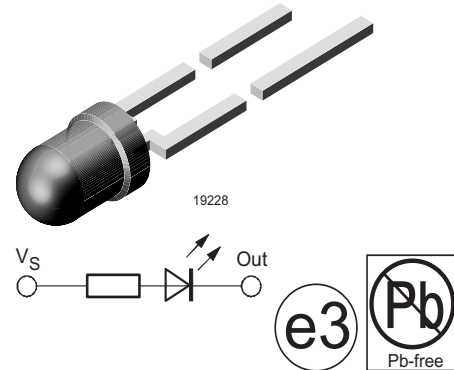

Applications

Status light in cars

OFF / ON indicator in cars

Background illumination for switches

Off / On indicator in switches

Features

- With current limiting resistor for 12 V
- EMC specified (DIN 40 839)
- Resistant against transient high voltage spikes
- Cost effective: save space and resistor cost
- Standard \varnothing 3 mm (T-1) package
- Wide viewing angle
- Choice of four bright colors
- Luminous intensity categorized
- Yellow and green color categorized
- Lead-free device

Parts Table

Part	Color, Luminous Intensity	Angle of Half Intensity ($\pm\phi$)	Technology
TLRH4420	Red, $I_V > 1.6$ mcd	30 °	GaAsP on GaP
TLRO4420	Soft orange, $I_V > 4$ mcd	30 °	GaAsP on GaP
TLRY4420	Yellow, $I_V > 1.6$ mcd	30 °	GaAsP on GaP
TLRG4420	Green, $I_V > 1.6$ mcd	30 °	GaP on GaP

Absolute Maximum Ratings

$T_{amb} = 25\text{ }^{\circ}\text{C}$, unless otherwise specified

TLRH4420, TLRO4420, TLR4420, TLRG4420

Parameter	Test condition	Symbol	Value	Unit
Reverse voltage		V_R	6	V
Forward voltage	$T_{amb} \leq 65\text{ }^{\circ}\text{C}$	V_F	16	V
Power dissipation	$T_{amb} \leq 65\text{ }^{\circ}\text{C}$	P_V	240	mW
Junction temperature		T_j	100	$^{\circ}\text{C}$
Operating temperature range		T_{amb}	- 40 to + 100	$^{\circ}\text{C}$
Storage temperature range		T_{stg}	- 55 to + 100	$^{\circ}\text{C}$
Soldering temperature	$t \leq 5\text{ s}$, 2 mm from body	T_{sd}	260	$^{\circ}\text{C}$
Thermal resistance junction/ambient		R_{thJA}	150	K/W

Optical and Electrical Characteristics

$T_{amb} = 25\text{ }^{\circ}\text{C}$, unless otherwise specified

Red

TLRH4420

Parameter	Test condition	Symbol	Min	Typ.	Max	Unit
Luminous intensity ¹⁾	$V_S = 12\text{ V}$	I_V	1.6	4		mcd
Dominant wavelength	$V_S = 12\text{ V}$	λ_d	612		625	nm
Peak wavelength	$V_S = 12\text{ V}$	λ_p		635		nm
Angle of half intensity	$V_S = 12\text{ V}$	ϕ		± 30		deg
Forward current	$V_S = 12\text{ V}$	I_F		10	12	mA
Breakdown voltage	$I_R = 10\text{ }\mu\text{A}$	V_{BR}	6	70		V
Junction capacitance	$V_R = 0$, $f = 1\text{ MHz}$	C_j		50		pF

¹⁾ in one Packing Unit $I_{Vmin}/I_{Vmax} \leq 0.5$

Soft Orange

TLRO4420

Parameter	Test condition	Symbol	Min	Typ.	Max	Unit
Luminous intensity ¹⁾	$V_S = 12\text{ V}$	I_V	4	10		mcd
Dominant wavelength	$V_S = 12\text{ V}$	λ_d	598		611	nm
Peak wavelength	$V_S = 12\text{ V}$	λ_p		605		nm
Angle of half intensity	$V_S = 12\text{ V}$	ϕ		± 30		deg
Forward current	$V_S = 12\text{ V}$	I_F		10	12	mA
Breakdown voltage	$I_R = 10\text{ }\mu\text{A}$	V_{BR}	6	70		V
Junction capacitance	$V_R = 0$, $f = 1\text{ MHz}$	C_j		50		pF

¹⁾ in one Packing Unit $I_{Vmin}/I_{Vmax} \leq 0.5$

Yellow

TLRY4420

Parameter	Test condition	Symbol	Min	Typ.	Max	Unit
Luminous intensity ¹⁾	$V_S = 12\text{ V}$	I_V	1.6	4		mcd
Dominant wavelength	$V_S = 12\text{ V}$	λ_d	581		594	nm
Peak wavelength	$V_S = 12\text{ V}$	λ_p		585		nm
Angle of half intensity	$V_S = 12\text{ V}$	ϕ		± 30		deg
Forward current	$V_S = 12\text{ V}$	I_F		10	12	mA
Breakdown voltage	$I_R = 10\ \mu\text{A}$	V_{BR}	6	70		V
Junction capacitance	$V_R = 0, f = 1\text{ MHz}$	C_j		50		pF

¹⁾ in one Packing Unit $I_{Vmin}/I_{Vmax} \leq 0.5$

Green

TLRG4420

Parameter	Test condition	Symbol	Min	Typ.	Max	Unit
Luminous intensity ¹⁾	$V_S = 12\text{ V}$	I_V	1.6	4		mcd
Dominant wavelength	$V_S = 12\text{ V}$	λ_d	562		575	nm
Peak wavelength	$V_S = 12\text{ V}$	λ_p		565		nm
Angle of half intensity	$V_S = 12\text{ V}$	ϕ		± 30		deg
Forward current	$V_S = 12\text{ V}$	I_F		10	12	mA
Breakdown voltage	$I_R = 10\ \mu\text{A}$	V_{BR}	6	70		V
Junction capacitance	$V_R = 0, f = 1\text{ MHz}$	C_j		50		pF

¹⁾ in one Packing Unit $I_{Vmin}/I_{Vmax} \leq 0.5$

Typical Characteristics ($T_{amb} = 25\text{ }^\circ\text{C}$ unless otherwise specified)

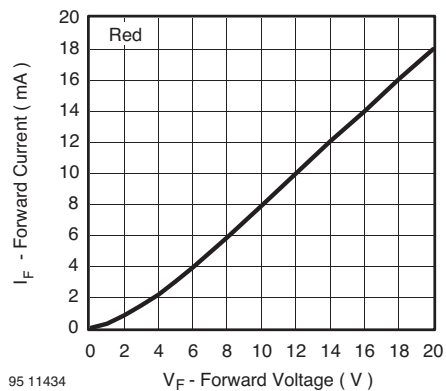

Figure 1. Forward Current vs. Forward Voltage

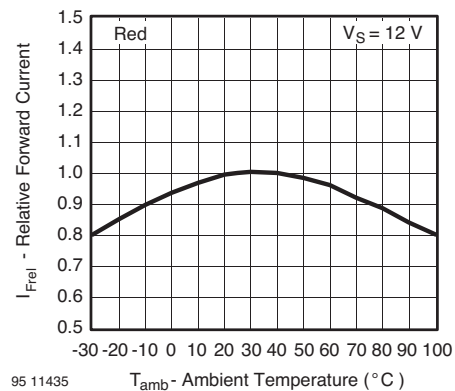

Figure 2. Relative Forward Current vs. Ambient Temperature

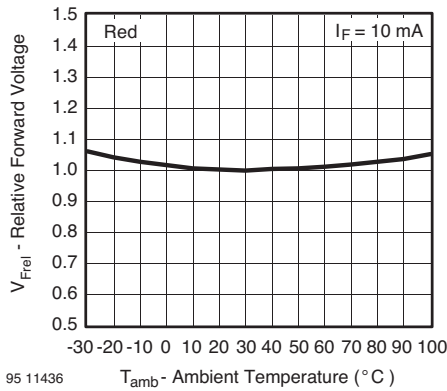

Figure 3. Relative Forward Voltage vs. Ambient Temperature

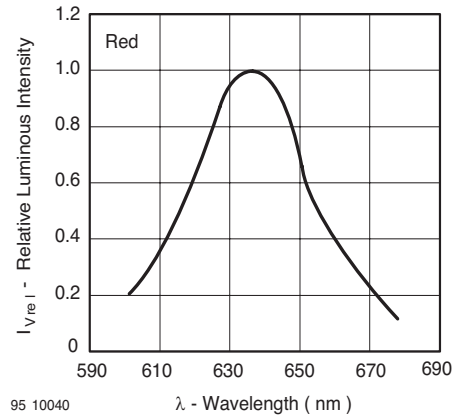

Figure 6. Relative Intensity vs. Wavelength

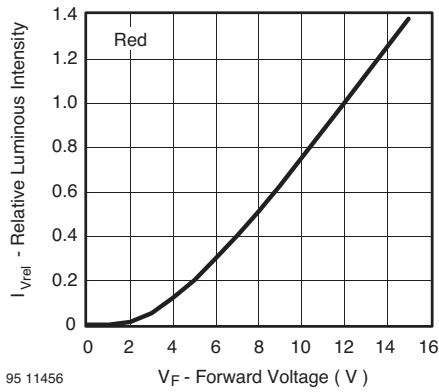

Figure 4. Relative Luminous Intensity vs. Forward Voltage

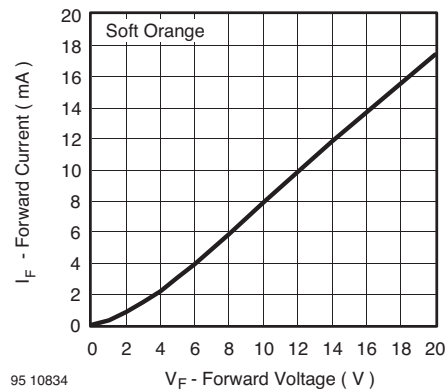

Figure 7. Forward Current vs. Forward Voltage

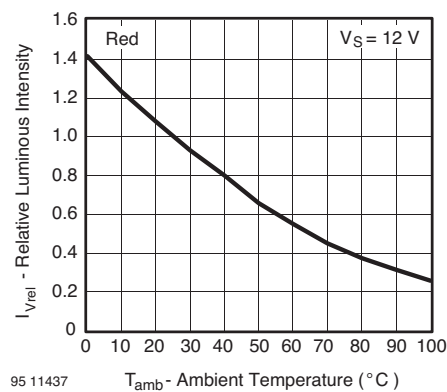

Figure 5. Rel. Luminous Intensity vs. Ambient Temperature

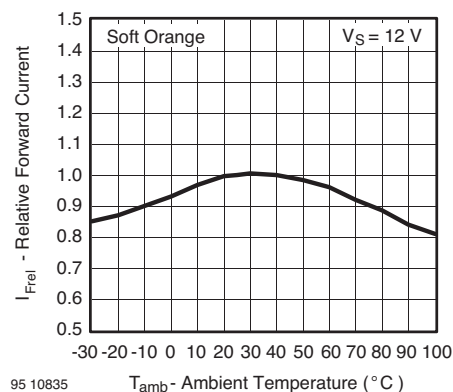

Figure 8. Relative Forward Current vs. Ambient Temperature

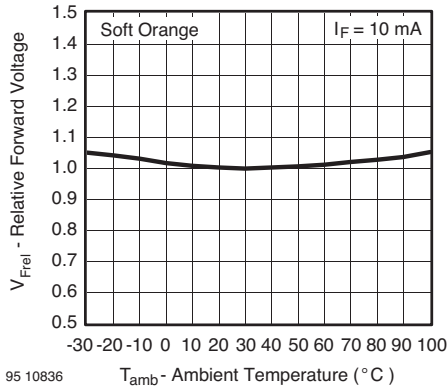

Figure 9. Relative Forward Voltage vs. Ambient Temperature

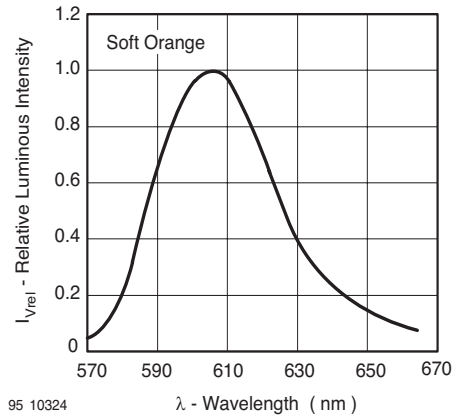

Figure 12. Relative Intensity vs. Wavelength

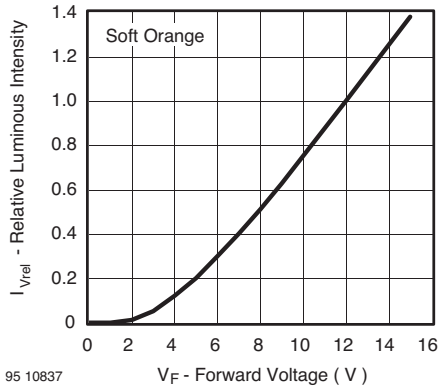

Figure 10. Relative Luminous Intensity vs. Forward Voltage

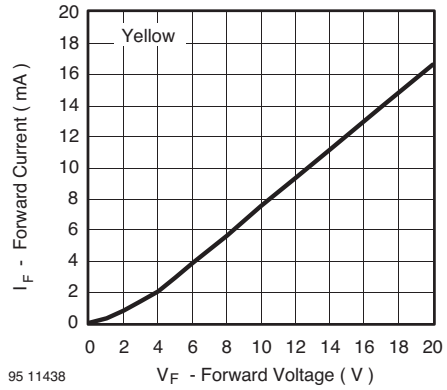

Figure 13. Forward Current vs. Forward Voltage

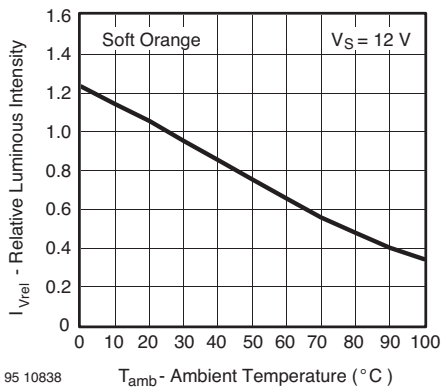

Figure 11. Rel. Luminous Intensity vs. Ambient Temperature

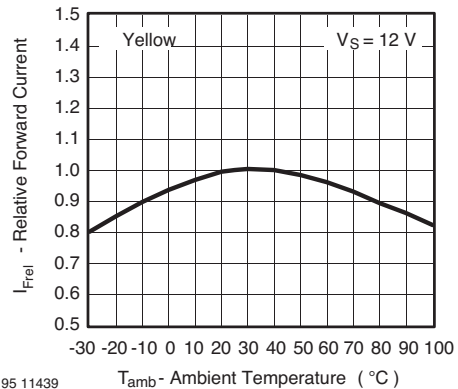

Figure 14. Relative Forward Current vs. Ambient Temperature

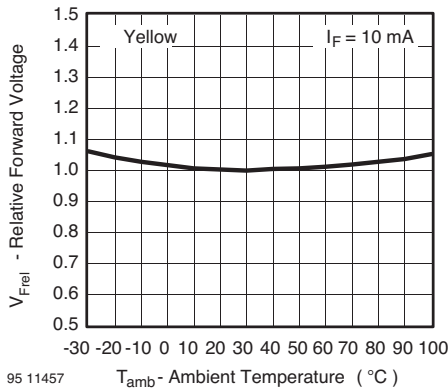

Figure 15. Relative Forward Voltage vs. Ambient Temperature

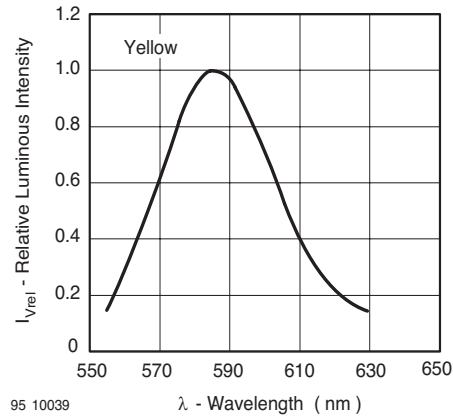

Figure 18. Relative Intensity vs. Wavelength

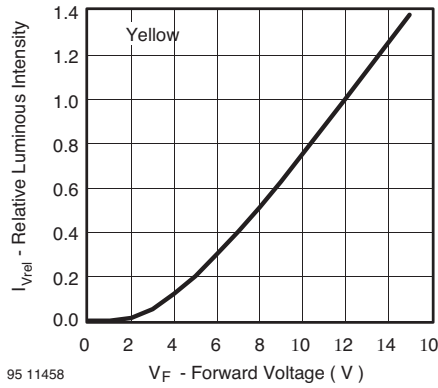

Figure 16. Relative Luminous Intensity vs. Forward Voltage

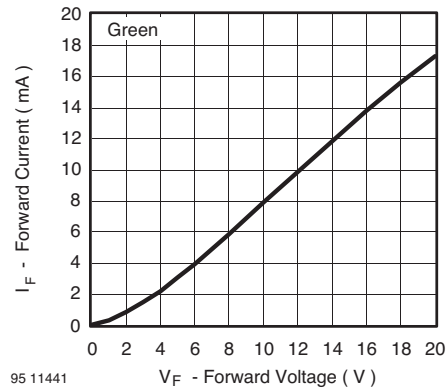

Figure 19. Forward Current vs. Forward Voltage

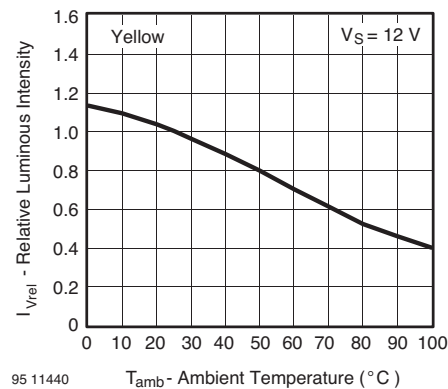

Figure 17. Rel. Luminous Intensity vs. Ambient Temperature

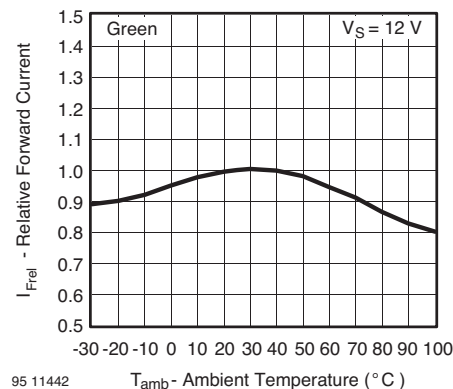

Figure 20. Relative Forward Current vs. Ambient Temperature

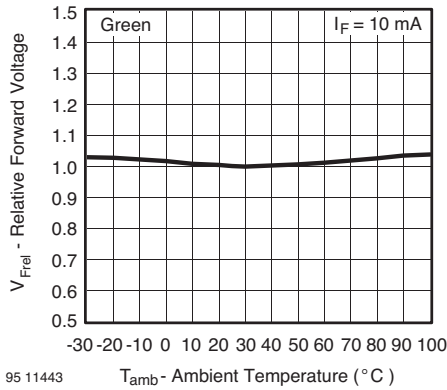

Figure 21. Relative Forward Voltage vs. Ambient Temperature

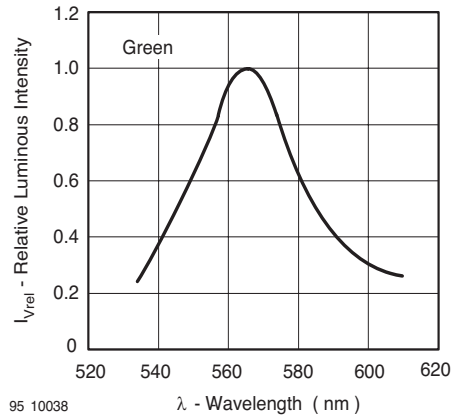

Figure 24. Relative Intensity vs. Wavelength

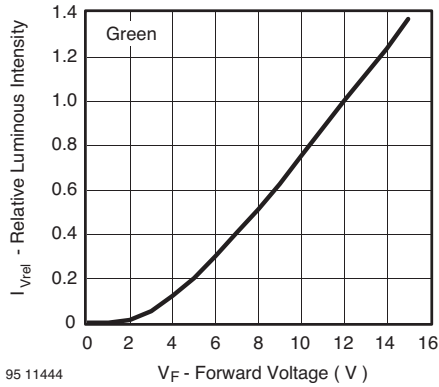

Figure 22. Relative Luminous Intensity vs. Forward Voltage

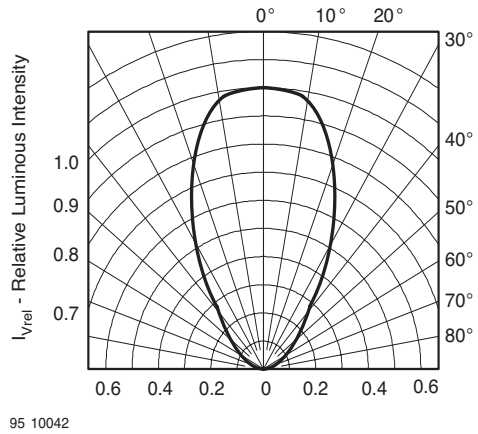

Figure 25. Rel. Luminous Intensity vs. Angular Displacement

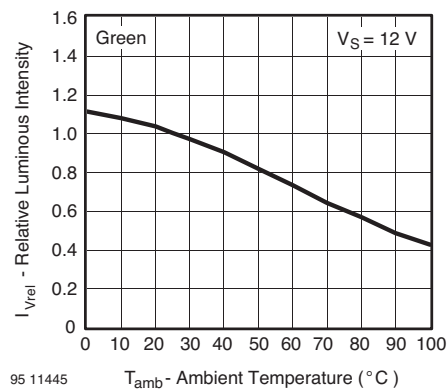
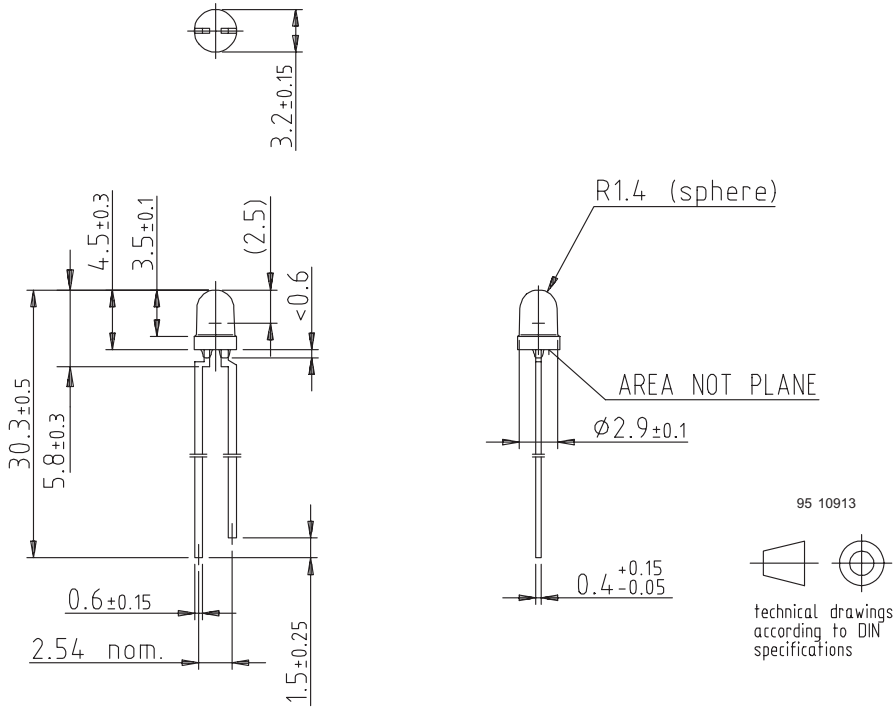

Figure 23. Rel. Luminous Intensity vs. Ambient Temperature

Package Dimensions in mm





Ozone Depleting Substances Policy Statement

It is the policy of **Vishay Semiconductor GmbH** to

1. Meet all present and future national and international statutory requirements.
2. Regularly and continuously improve the performance of our products, processes, distribution and operating systems with respect to their impact on the health and safety of our employees and the public, as well as their impact on the environment.

It is particular concern to control or eliminate releases of those substances into the atmosphere which are known as ozone depleting substances (ODSs).

The Montreal Protocol (1987) and its London Amendments (1990) intend to severely restrict the use of ODSs and forbid their use within the next ten years. Various national and international initiatives are pressing for an earlier ban on these substances.

Vishay Semiconductor GmbH has been able to use its policy of continuous improvements to eliminate the use of ODSs listed in the following documents.

1. Annex A, B and list of transitional substances of the Montreal Protocol and the London Amendments respectively
2. Class I and II ozone depleting substances in the Clean Air Act Amendments of 1990 by the Environmental Protection Agency (EPA) in the USA
3. Council Decision 88/540/EEC and 91/690/EEC Annex A, B and C (transitional substances) respectively.

Vishay Semiconductor GmbH can certify that our semiconductors are not manufactured with ozone depleting substances and do not contain such substances.

**We reserve the right to make changes to improve technical design
and may do so without further notice.**

Parameters can vary in different applications. All operating parameters must be validated for each customer application by the customer. Should the buyer use Vishay Semiconductors products for any unintended or unauthorized application, the buyer shall indemnify Vishay Semiconductors against all claims, costs, damages, and expenses, arising out of, directly or indirectly, any claim of personal damage, injury or death associated with such unintended or unauthorized use.

Vishay Semiconductor GmbH, P.O.B. 3535, D-74025 Heilbronn, Germany
Telephone: 49 (0)7131 67 2831, Fax number: 49 (0)7131 67 2423



Disclaimer

All product specifications and data are subject to change without notice.

Vishay Intertechnology, Inc., its affiliates, agents, and employees, and all persons acting on its or their behalf (collectively, "Vishay"), disclaim any and all liability for any errors, inaccuracies or incompleteness contained herein or in any other disclosure relating to any product.

Vishay disclaims any and all liability arising out of the use or application of any product described herein or of any information provided herein to the maximum extent permitted by law. The product specifications do not expand or otherwise modify Vishay's terms and conditions of purchase, including but not limited to the warranty expressed therein, which apply to these products.

No license, express or implied, by estoppel or otherwise, to any intellectual property rights is granted by this document or by any conduct of Vishay.

The products shown herein are not designed for use in medical, life-saving, or life-sustaining applications unless otherwise expressly indicated. Customers using or selling Vishay products not expressly indicated for use in such applications do so entirely at their own risk and agree to fully indemnify Vishay for any damages arising or resulting from such use or sale. Please contact authorized Vishay personnel to obtain written terms and conditions regarding products designed for such applications.

Product names and markings noted herein may be trademarks of their respective owners.